

- 60945 Conversion Decoder Set for a Steam Locomotive
  - 60946 Conversion Decoder Set for a Diesel Locomotive
  - 60947 Conversion Decoder Set for a Electric Locomotive
-

<b>Table of Contents</b>	<b>Page</b>
Using the Product as Intended	3
Contents	3
Safety Notes	3
Technical Information	4
Functions	4
Decoder Installation	5
Multi-Protocol Operation	6
- mfx-Protocol	7
- fx-Protocol	7
- DCC-Protocol	8
Physical Functions	8
Logic Functions	8
Decoder functions and CV settings	9
Controllable Functions	10
Volume settings	13
CV Table for fx (MM)	14
CV Table for DCC	18
Troubleshooting Problems	23
Disposing	23
Warranty	23
My personal decoder settings	24

## Using the Product as Intended

The 60945/60946/60947 decoders are for converting Märklin/Trix H0 locomotives to digital.

! Not suitable for motors with field-wound coils. Locomotives with these motors must be converted with the appropriate motor retrofit kits, item numbers 60941, 60943, or 60944.

! Important: The following locomotives (locomotive-specific decoder) cannot be converted with this decoder.

Item:

26410	37346	37777	39340
26453	37403	37786	39343
26490	37404	37787	39390
26557	37435	37790	39392
26561	37485	37791	39393
26562	37501	37867	39399
29094 (only E 94)	37504	37940	39404
29440 (only E 10)	37505	37941	39441
29500 (only E 50)	37530	37993	39563
37010	37542	39014	39564
37011	37573	39022	39565
37044	37574	39051	39643
37226	37575	39081	39836
37227	37580	39110	39837
37239	37581	39123	39838
37274	37607	39140	39896
37275	37733	39185	39972
37321	37734	39303	39986

## Contents as Delivered

1 decoder  
1 circuit board with a 21-pin connector  
1 circuit board retainer  
1 screw  
1 speaker small  
1 speaker big  
1 adhesive pad  
Installation instructions  
Warranty card

Tools also needed for the installation procedure include: regular and cross-point screwdrivers, tweezers, and soldering station with a maximum soldering temperature of up to 30 watts / 300°Celsius / 572°Fahrenheit with a fine tip, soldering flux for electronics (0.5 - 1 mm / 0.02" - 0.04" diameter), de-soldering braid or a de-soldering pump.

## Safety Notes

- **WARNING!** Sharp edges and points required for operation.
- Do wiring and assembly work only on a voltage-free or grounded work mat. Failure to do this can lead to dangerous static charge from your body and to damage to the components.
- **Operate the decoder only with the authorized voltage** (see technical data).



There is a danger of **burning yourself** when working with a soldering station.

## Technical Information

- Continuous current load at the motor output  $\leq 1.1$  amps
- Current load at the light outputs  $\leq 250$  milliamps
- Current load at AUX 1 – AUX 2 each  $\leq 250$  milliamps
- Current load at AUX + lights (total)  $\leq 300$  milliamps
- Current load for motor and AUX 5/6  $\leq 1.1$  amps
- Maximum total load  $\leq 1.6$  amps
- Maximum voltage  $\leq 40$  volts
- Sound performance (at 4  $\Omega$  / 8  $\Omega$ ) 2.3 watts / 1.2 watts
- Short circuit and overload protection at the outputs lights front (LV), lights rear (LH), AUX 1 – AUX 4 and at the motor outputs.

## Functions

The mSD SoundDecoder is a sound decoder with very extensive setting and adaptation possibilities. Additional sound functions are available. This decoder can be updated. The requirement for this is an appropriate controller (60213/60214/60215 Central Station, software Version 2.0, track format processor GFP 2.0 or higher).

The settings and digital functions can only be used in digital operation. However, the same possibilities are not available in all protocols.

These instructions describe the installation and the possible settings for the 60945, 90946 and 60947 decoders. Unless otherwise stated, the functions refer to both decoders.

- Capable of multi-protocols (fx (MM), mfx, DCC, and AC/DC).
- Automatic system recognition. The address assigned to each system must be used for operation.

- Acceleration and braking delay can be set separately from each other. Any function button desired can be assigned using the function mapping.
- Typical sound backdrops for diesel and electric locomotives are included.
- Variable motor feedback control is available in digital as well as in analog operation.
- 6090, 60901, DC, and can motors with bell-shaped armatures are supported. See **necessarily** this table on page 3. These locomotives can not be converted this set.
- Function mapping included.
- Can be updated with the CS2 (Software 2.0, track format processor GFP 2.0 or higher).
- Programming on the Main (PoM) this type of programming must be supported by the controller. Please note the instructions for your controller when doing this.
- Switching range can be set.
- Braking / signal stopping block recognition is available in digital operation.

## Decoder Installation

The locomotive must be checked before installing the decoder to make sure that it (locomotive) is in good mechanical and electrical condition. There are situations when the locomotive will have to be repaired before installing the decoder.

First unsolder the wires to the current pickups (pickup shoe(s)), motor, and the lights. After that remove the old decoder or reverse unit. Screw down the circuit board retainer and solder the wires to the motor connections, pickup(s), and any functions.

The **colors for the wires** correspond to the **Märklin Standard**; see Page 6 for a comparison table for NEM. Position the new decoder and solder the wires according to the diagram nearby.

If the lights are grounded to the locomotive's or powered rail car's ground on the frame, we recommend that the lights be insulated from the locomotive ground. To do this, use the E604180 plug-in bulb holder(s) and E610080 light bulb(s). This will give you flicker-free lighting.

If your locomotive or powered rail car is equipped with LED lighting, then series resistors must absolutely be installed. Series resistors differ according to the current the design. Find out the correct values for your LEDs. You may have to ask your specialty dealer about this.

If you want to retrofit your locomotive or powered rail car with LEDs, the cathodes (-) on the LED are connected to the light output on the decoder. **Don't forget** series resistors! The anodes (+) are connected to the common wire (blue). The common ground return (blue) must not be connected to the ground for the locomotive or powered rail car.

Position the speakers, fasten it with the adhesive pad and put the cable into the connector on the circuit board.

This procedure is identical for the 60945, 60946 and 60947 decoder. Make sure that you pay absolute attention to the **notes** for the **colors of the wires** for each decoder.

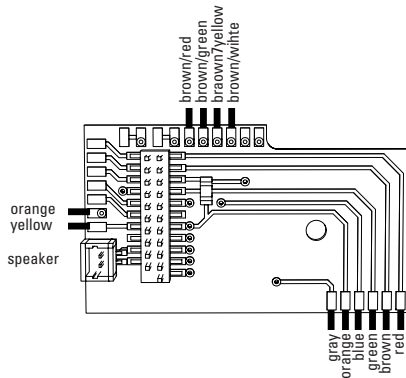

If the lighting is grounded to the locomotive or powered rail car's frame, this may cause flickering. If you don't want this, then the lighting must be insulated. We recommend replacing the light bulb(s) with the 604180 plug-in socket(s) and the 610080 light bulb(s). The ground is then connected to the orange wire.

Insert the plug into the connector while paying attention to the positioning. Place the model, with the body left off, on the programming track and test it. If the decoder works with no problems, the body can be put on the locomotive.

### Cross Referencing the Colors for the Wires

Description	Wire Color	
	NEM	Märklin
Motor Connection 2	gray	blue
Conductor Current Pickup, Track, Left (DC) Outer (AC)	black	brown
Front Lights	white	gray
Function 1	green	brown/red
Common Wire for Lights	blue	orange
Rear Lights	yellow	yellow
Conductor Current Pickup, Track, Right (DC) Center (AC)	red	red
Motor Connection 1	orange	green
Speaker +	brown	white
Speaker -	brown	white
Aux 2 (physical output)	violet	brown/green
Aux 3 (physical output)		brown/yellow
Aux 4 (physical output)		brown/white

## Multi-Protocol Operation

### Analog Operation

This decoder can also be operated on analog layouts or areas of track that are analog. The decoder recognizes alternating current or direct current voltage (AC/DC) and automatically adapts to the analog track voltage. All functions that were set under mfx or DCC for analog operation are active (see Digital Operation).

### Digital Operation

The mSD sound decoders are multi-protocol decoders. These decoders can be used under the following digital protocols: mfx, DCC, fx (MM).

The digital protocol with the most possibilities is the highest order digital protocol. The sequence of digital protocols in descending order is:

- Priority 1: mfx
- Priority 2: DCC
- Priority 3: fx (MM)

**Note:** Digital protocols can influence each other. For trouble-free operation, we recommend deactivating those digital protocols not needed by using CV 50. Deactivate unneeded digital protocols at this CV if your controller supports this function.

If two or more digital protocols are recognized in the track, the decoder automatically takes on the highest order digital protocol, example: mfx/DCC; the decoder takes on the mfx digital protocol (see previous table).

**Note:** Please note that not all functions are possible in all digital protocols. Several settings for functions, which are supposed to be active in analog operation, can be done under mfx and DCC.

### **Braking / Signal Stopping Block (MM, fx, mfx)**

The braking module essentially applies DC voltage to the track. If the decoder recognizes a DC voltage of this kind in the track, it brakes with the delay that has been set. If the decoder recognizes a digital protocol again, it accelerates at the speed that has been set.

If automatic recognition in braking areas is to be used, we recommend shutting the DC operation off (see CV description).

### **mfx Protocol**

#### **Addresses**

- No address is required; each decoder is given a one-time, unique identifier (UID).
- The decoder automatically registers itself on a Central Station or a Mobile Station with its UID.

#### **Programming**

- The characteristics can be programmed using the graphic screen on the Central Station or also partially with the Mobile Station.
- All of the Configuration Variables (CV) can be read and programmed repeatedly.
- The programming can be done either on the main track or the programming track.

- The default settings (factory settings) can be produced repeatedly.
- Function mapping: Functions can be assigned to any of the function buttons with the help of the 60212 Central Station (with limitations) and with the 60213/60214/60215 Central Station (See help section in the Central Station).

### **fx (Motorola) Protocol**

#### **Addresses**

- 4 addresses (a main address and 3 consecutive addresses)
- Address range:  
1 - 255 depending on the controller / central controller
- The main address can be programmed manually.
- The consecutive addresses can be turned on, turned off, set and can be programmed manually or automatically.
- All 16 functions can be controlled by means of the four addresses.

#### **Programming**

- The characteristics can be programmed for the decoder can be programmed repeatedly using the programming for the Configuration Variables (CV). Reading the CVs is not possible.
- The CV numbers and the CV values are entered directly.
- Program the CVs only on the programming track. (Seite 9, rechts - Fortsetzung)
- The default settings (factory settings) can be produced repeatedly.
- 14 or 27 speed levels can be programmed.

- The first four functions and the lights can always be controlled by means of the first address; additional functions can be used, depending on the consecutive addresses.
- All of the settings from the function mapping for mfx or DCC programming are taken on for fx (Motorola).
- Automatic recognition corresponding to the active additional or consecutive addresses. What is recognized is whether the function can be turned on or off continuously by means of a consecutive address. This function mapping can only be determined in the mfx or DCC protocol.
- See the CV description for the fx protocol for additional information.

## DCC Protocol

### Addresses

- Short address – long address – multiple unit address
- Address range:  
1 - 127 for short address and multiple unit address,  
1 - 10239 for long address
- Every address can be programmed manually.
- A short or a long address is selected using the CVs.
- A multiple unit address that is being used deactivates the standard address.

### Programming

- The characteristics can be changed repeatedly using the Configuration Variables (CV).
- The CV numbers and the CV values are entered directly.
- The CVs can be read and programmed repeatedly. (Programming is done on the programming track.)

- The CVs can be programmed in any order desired. (Programming can be done on the main track PoM). The PoM can only be done with those designated in the CV table. Programming on the main track PoM must be supported by your central controller (Please see the description for this unit).
- The default settings (factory settings) can be produced repeatedly.
- 14/28 or 126 speed levels can be set.
- All of the functions can be controlled according to the function mapping (see CV description).
- See the CV description for the DCC protocol for additional information.

We recommend that in general programming should be done on the programming track.

## Physical Functions

Each of these functions must be connected externally to the circuit board. We therefore speak of physical functions. A unique mode/effect can be assigned to each physical output (AUX / lights) in digital operation. Three CVs are available for each output for this purpose. Only one mode/effect can be set for each output. A complete table for this can be found on the Internet at:  
[www.maerklin.de/de/produkte/tools\\_downloads/technische\\_infos.html](http://www.maerklin.de/de/produkte/tools_downloads/technische_infos.html)

## Logic Functions

Since these functions are only executed by software, no physical output is required for them. We therefore speak here of a logic function.



### **Acceleration/Braking Delay**

- The acceleration and braking time can be set separately from each other.
- The logic function ABV can be assigned to any function button by using the function mapping.

### **Switching Range (RG)**

- The switching range causes a reduction in the current speed of the locomotive. This allows a fine touch in the controlling the locomotive. The switching range can be assigned in mfx and DCC to any function button by using the function mapping.

### **Station Announcement**

The locomotive does not go until after the announcement has ended.







### **Decoder functions and CV settings**

The following pages have the functions and the CVs presented in tabular form. These CVs can be given a number of settings and can be assigned to a number of function buttons.

You'll find the CVs and their applications for the track formats fx (MM) and DCC in separate tables.

The track format mfx can be easily set by using the display on the CS 2 with Software Version 2.0 and higher. You or your dealer may have to install an update on your 60213/60214/60215 Central Station.







## Decoder 60945

Controllable Functions					 Digital/Systems
Headlights	function/off			Function f0	Function f0
Smoke generator (Aux1)	f1	Function 1	Function *	Function f1	Function f1
Sound effect: Operating sounds	f2	Function 2	Function *	Function f2	Function f2
Sound effect: Whistle blast	f3	Function 3	Function *	Function f3	Function f3
ABV off	f4	Function 4	Function *	Function f4	Function f4
Sound effect: Buffer to buffer	— <sup>1</sup>	—	Function *	Function f5	Function f5
Switching range + double A light	— <sup>1</sup>	—	Function *	Function f6	Function f6
Sound effect: Bell	— <sup>1</sup>	—	Function *	Function f7	Function f7
Telex coupler (Aux 2)	— <sup>1</sup>	—	Function *	Function f8	Function f8
Sound effect: Squealing brakes off	— <sup>1</sup>	—	—	Function f9	Function f9
Sound effect: Coal being shoveled	— <sup>1</sup>	—	—	Function f10	Function f10
Sound effect: Short whistle blast	— <sup>1</sup>	—	—	Function f11	Function f11
Sound effect: Station announcements	— <sup>1</sup>	—	—	Function f12	Function f12
Sound effect: Rocker grate	— <sup>1</sup>	—	—	Function f13	Function f13
Sound effect: Rail joints	— <sup>1</sup>	—	—	Function f14	Function f14
Sound effect: Conductor whistle	— <sup>1</sup>	—	—	Function f15	Function f15

<sup>1</sup> can be controlled by using consecutive addresses

\*Function and Function symbols may be displayed in different order.







## Decoder 60946

Controllable Functions					 Digital/Systems
Headlights	function/off			Function f0	Function f0
Engineer's cab lighting (Aux 1)	f1	Function 1	Function *	Function f1	Function f1
Sound effect: Operating sounds	f2	Function 2	Function *	Function f2	Function f2
Sound effect: Horn 1	f3	Function 3	Function *	Function f3	Function f3
ABV switching off	f4	Function 4	Function *	Function f4	Function f4
Sound effect: Coupling together	— <sup>1</sup>	—	Function *	Function f5	Function f5
Sound effect: Uncoupling	— <sup>1</sup>	—	Function *	Function f6	Function f6
Sound effect: Horn 2	— <sup>1</sup>	—	Function *	Function f7	Function f7
Telex coupler (Aux 2)	— <sup>1</sup>	—	Function *	Function f8	Function f8
Sound effect: Squealing brakes off	— <sup>1</sup>	—	—	Function f9	Function f9
Sound effect: Blower	— <sup>1</sup>	—	—	Function f10	Function f10
Sound effect: Bell	— <sup>1</sup>	—	—	Function f11	Function f11
Sound effect: Station announcements	— <sup>1</sup>	—	—	Function f12	Function f12
Sound effect: Auxiliary diesel	— <sup>1</sup>	—	—	Function f13	Function f13
Sound effect: Rail joints	— <sup>1</sup>	—	—	Function f14	Function f14
Sound effect: Conductor whistle	— <sup>1</sup>	—	—	Function f15	Function f15

<sup>1</sup> can be controlled by using consecutive addresses

\*Function and Function symbols may be displayed in different order.

## Decoder 60947

Controllable Functions					 Digital/Systems
Headlights	function/off			Function f0	Function f0
Long distance headlights (Aux 1)	f1	Function 1	Function *	Function f1	Function f1
Sound effect: Operating sounds	f2	Function 2	Function *	Function f2	Function f2
Sound effect: Horn 1	f3	Function 3	Function *	Function f3	Function f3
ABV switching off	f4	Function 4	Function *	Function f4	Function f4
Sound effect: Buffer to buffer	— <sup>1</sup>	—	Function *	Function f5	Function f5
Sound: Checking train tickets	— <sup>1</sup>	—	Function *	Function f6	Function f6
Sound effect: Horn 2	— <sup>1</sup>	—	Function *	Function f7	Function f7
Telex coupler (Aux 2)	— <sup>1</sup>	—	Function *	Function f8	Function f8
Sound effect: Squealing brakes off	— <sup>1</sup>	—	—	Function f9	Function f9
Sound effect: Blower	— <sup>1</sup>	—	—	Function f10	Function f10
Sound effect: Short whistle blast	— <sup>1</sup>	—	—	Function f11	Function f11
Sound effect: Station announcements	— <sup>1</sup>	—	—	Function f12	Function f12
Sound effect: Compressor	— <sup>1</sup>	—	—	Function f13	Function f13
Sound effect: Rail joints	— <sup>1</sup>	—	—	Function f14	Function f14
Sound effect: Conductor whistle	— <sup>1</sup>	—	—	Function f15	Function f15

<sup>1</sup> can be controlled by using consecutive addresses

\*Function and Function symbols may be displayed in different order.

## Volume

**mfx protocol:** The total volume for the sound functions can be changed easily with the 60213/60214/60215 Central Station in the CV menu "Sound". The function mapping (assigning the function buttons) and the individual volume settings are done with the function buttons. The sound number is required for the function mapping.

**fx protocol:** In the fx protocol only the total volume can be changed with CV 63. It is not possible to change the individual volumes. However, settings done under mfx are preserved.

**DCC protocol:** The volume can be changed by using the CVs below. The sound number is required for the function mapping and for the assignment of the CVs to the sound.

Sound functions	Sound-Nr.						Default	Values
	CV	Steam	CV	Diesel	CV	Electric		
Total volume	63	all	63	all	63	all	255	0 - 255
Sound effect: Function f2	139	Running sounds	139	Running sounds	139	Running sounds	180	0 - 255
Sound effect: Function f3	140	1	140	1	140	1	180	0 - 255
Physical Functions f5	—	—	—	—	—	—	—	—
Physical Functions f6	—	—	—	—	—	—	—	—
Sound effect: Function f7	141	2	141	2	141	2	180	0 - 255
Physical Functions f8	—	—	—	—	—	—	—	—
Sound effect: Function f9	138	Brake sounds	138	Brake sounds	138	Brake sounds	180	0 - 255
Sound effect: Function f10	148	9	148	9	148	9	180	0 - 255
Sound effect: Function f11	142	3	142	3	142	3	180	0 - 255
Sound effect: Function f12	143	4	144	5	144	5	180	0 - 255
Sound effect: Function f13	149	10	146	7	150	11	180	0 - 255
Sound effect: Function f14	153	14	153	14	153	14	180	0 - 255
Sound effect: Function f15	144	5	145	6	145	6	180	0 - 255

### CV Table for fx (MM)

CV	Explanation	Values	Default	Notes
1	Address 1 (main address)	1-255 (1 - 80)*	60945=78 60946=72 60947=24	Address is always active and is not subject to CV 49..
2	Minimum speed (Vmin)	1-255 (1 - 80)*	5	Speed at the smallest speed level. Value must be smaller than Vmax, CV 5.
3	Acceleration delay (AV)	1-255 (1 - 80)*	25	CV value multiplied by 0.25 gives the time from complete stop to maximum speed.
4	Braking delay (BV)	1-255 (1 - 80)*	16	CV value multiplied by 0.25 gives the time from Maximum speed to complete stop.
5	Maximum speed (Vmax)	1-255 (1 - 63)* {x4}*	255	Speed at the highest speed level. Value must be greater than CV 2.
8	Decoder reset (default or factory setting)	8		Value is not written.
17	Address 3 (2nd consecutive address)	1-255 (1 - 80)*	254	Address can be deactivated/activated subject to CV 49.
18	Address 4 (3rd consecutive address)	1-255 (1 - 80)*	253	Address can be deactivated/activated subject to CV 49.
27	Braking mode: Bit 0 - 3 : always 0, Bit 4 : DC voltage, polarity against the direction of travel Bit 5 : DC voltage, polarity with the direction of travel Bit 6 - 7 : always	0 - 48 0 16 32 0	48	Braking subject to direction: - 16 normal DCC properties - 32 inverse DCC properties Braking not subject to direction: - 48: fx/mfx properties

\* ( ) = 6021 Control Unit {} = the values entered are multiplied times "x" (factor).

### CV Table for fx (MM)

CV	Explanation	Values	Default	Notes
29	<p>Configuration:</p> <p>Bit 0: Reverse the locomotive's direction properties 0 = normal direction 1 = invert direction</p> <p>Bit 1: number of speed levels half levels 14 or 27 0 = 14 speed levels 1 = 27 speed levels / half levels</p> <p>Bit 2: turn analog operation on/off 0 = analog off, 1 = analog on</p>	0 - 7	6	<p>The direction properties refer to the direction of travel and the lights.</p> <p>The number of speed levels and half levels depend on the locomotive controller.</p> <p>Only digital operation or also conventional operation. Flipping back and forth between the modes is possible during operation.</p>
49	<p>Expanded configuration:</p> <p>Bit 0: number of addresses, LSB</p> <p>Bit 1: number of addresses, MSB</p> <p>Bit 2: automatic consecutive addressing (on / 1=off)</p>	0 - 7	5	<p>0 = one   1 = two   0 = three   1 = four 0 Add.   0 Add.   1 Add.   1 Add. 0 = auto. sequence on / 1 = auto. sequence off</p>
50	<p>Alternative formats:</p> <p>Bit 0: analog AC off = 0 / analog AC on = 1</p> <p>Bit 1: analog DC off = 0 / analog DC on = 1</p> <p>Bit 2: DCC off = 0 / DCC on = 1</p> <p>Bit 3: mfx off = 0 / mfx on = 1</p>	0 - 15	15	<p>Note: fx (Motorola) cannot deactivate itself</p>

\* ( ) = 6021 Control Unit {} = the values entered are multiplied times "x" (factor).

## CV Table for fx (MM)

CV	Explanation	Values	Default	Notes
52	Motor type ... (Bit 0-4)	0 - 63	3	Selection of a motor type for additional settings for motor feedback control.  or Selection of additional function outputs on an H0 decoder. See extra table <sup>1</sup> for how motor outputs work as additional auxiliary functions.
	... Auxiliary function outputs 5 and 6	0		
	... Motor – Softdrive Sine	1		
	... Motor – without feedback control	2		
	... Motor – High efficiency propulsion C90	3		
	... Motor – Bell armature	4		
	... Motor – direct current DC soft	5		
	... Motor – direct current DC hard	6		
	... Motor – direct current DC 1 Gauge	7		
	also analog with feedback control ... (Bit 5)			
... 0 : with analog with feedback control	0			
... 1 : without analog with feedback control	32			
53	Motor feedback control – feedback control reference	1 - 255 (0 - 63)* {x4}*	150	Absolute Vmax for motor characteristic
54	Motor feedback control – feedback control parameter K	1 - 255 (0 - 63)* {x4}*	64	Feedback control portion P
55	Motor feedback control – feedback control parameter I	1 - 255 (0 - 63)* {x4}*	64	Feedback control portion I
56	Motor feedback control – feedback control influence	1 - 255 (0 - 63)* {x4}*	24	0 = PWM without feedback control for Sine (see also CV 52 motor type)
57	Steam locomotive sound interval of the steam chuffing at speed level 1	1 - 255 (0 - 63)* {x4}*	46	without a wheel sensor
58	Steam locomotive interval of the steam chuffing starting at speed level 2,	1 - 255 (0 - 63)* {x4}*	95	without a wheel sensor
63	Total volume	1 - 255 (0 - 63)* {x4}*	255	Total volume for all sounds. 0 = no sound

\* ( ) = 6021 Control Unit {} = the values entered are multiplied times "x" (factor).

\* An extensive table for function mapping can be found on the Internet at:  
[www.maerklin.de/de/produkte/tools\\_downloads/technische\\_infos.html](http://www.maerklin.de/de/produkte/tools_downloads/technische_infos.html)



### CV Table for fx (MM)

CV	Explanation	Values	Default	Notes
64	Threshold for brake squealing	1 - 255 (0 - 63)* {x4}*	55	The higher the value the sooner the squealing begins, the lower the value the later the squealing begins. If the value is too low, no squealing is activated.
73	Storing different states: Bit 0: storing function states Bit 1: storing speed Bit 2: starting up with/without ABV after a reset	0 - 7 0 / 1 0 / 2 0 / 4	7	0 = do not store / 1 = store 0 = do not store / 2 = store 0 = without ABV / 4 = with ABV
74	Storing different states: Bit 0: storing direction of travel	0 - 1	1	0 = do not store / 1 = store
75	Address 2 (1st consecutive address)	1 - 80	60945=79 60946=73 60947=25	Address can be activated/deactivated subject to CV 49.
76	Analog DC startup voltage	1 - 63 {x4}*	100	Note for CS1: (140) The CS1 shows this value inverted.
77	Analog DC maximum speed	1 - 63 {x4}*	255	
78	Analog AC startup voltage	1 - 63 {x4}*	100	Note for CS1: (140) The CS1 shows this value inverted.
79	Analog AC maximum speed	1 - 63 {x4}*	255	

\* () = 6021 Control Unit {} = the values entered are multiplied times "x" (factor).

## CV Table for DCC

CV	Explanation	Values	Default	Notes
1	Main address	1 - 127	3	Short address 1 - 127 If CV 29 / Bit 5 = 0
2 <sup>PoM</sup>	Minimum speed (Vmin)	0 - 255	5	Value must be lower than Wert muss Vmax, CV 5. (see CV 67)
3 <sup>PoM</sup>	Acceleration delay (AV)	0 - 255	25	CV value multiplied by 0.9 gives the time from being stopped to maximum speed.
4 <sup>PoM</sup>	Braking delay (BV)	0 - 255	16	CV value multiplied by 0.9 gives the time from maximum speed to being stopped.
5 <sup>PoM</sup>	Maximum speed (Vmax)	0 - 255	255	Speed at the highest speed level. Value must be higher than Vmin, CV 2.(see also CV 94)
7	Manufacturer's version number (software version)			Read only
8	Manufacturer identification / ID Decoder reset (default or factory setting)	- 8	131	Read only Value cannot be read
13 <sup>PoM</sup>	Functions F1 - F8 with an alternative track signal	0 - 255	60945=1 60946=0 60947=0	0 = Func. MM or analog off 1 = Func. MM or analog on [ F8 F7 F6 F5 F4 F3 F2 F1 ]
14 <sup>PoM</sup>	Functions FL, F9 - F15 with an alternative track signal	0 - 255	1	0 = Func. MM or analog off 1 = Func. MM or analog on [ F15 F14 F13 F12 F11 F10 F9 FL ]
17	Expanded address, higher value byte	192 - 231	192	Long address 1 - 10239 (128)
18	Expanded address, lower value byte	0 - 255	128	If CV 29 / Bit 5 = 1

PoM ("Programming on Main") must be supported by the locomotive controller / central controller.

## CV Table for DCC

CV	Explanation	Values	Default	Notes
19	Multiple unit address	0 - 255	0	1 - 127 = multiple unit address 0 = no multiple unit +128, Bit 7 = reverse polarity for direction when using multiple unit
21 <sup>PoM</sup>	Functions F1 - F8 when using multiple unit	0 - 255	0	0 = func. # only for locomotive address 1 = func. # also for multiple unit address Bit 7-0 = [ F8 F7 F6 F5 F4 F3 F2 F1 ]
22 <sup>PoM</sup>	Functions FL, F9 - F15 when using multiple unit	0 - 255	0	0 = func. # only for locomotive address 1 = func. # also for multiple unit address Bit 7-0 = [ F15 F14 F13 F12 F11 F10 F9 FL ]
27 <sup>PoM</sup>	Braking mode: Bit 0 - 3 : always 0, Bit 4 : DC voltage, polarity against the direction of travel Bit 5 : DC voltage, polarity with the direction of travel Bit 6 - 7 :	0 - 48 0 0 / 16 0 / 32 0	48	Braking subject to direction: - only Bit 4 : normal DC properties - only Bit 5 : inverse DC properties Braking not subject to direction: - Bit 4 + 5 : 3 rail properties
29 <sup>PoM</sup>	Configuration: Bit 0 : reverses direction properties of the locomotive 0 = normal direction, 1 = inverse direction Bit 1 : speed level 14 or select 28/128 0 = 14 speed levels, 1 = 28/128 speed levels Bit 2 : turn analog operation off/on 0 = analog off, 1 = analog on Bit 5 : select short / long address 0 = short address, 1 = long address	0 - 39 0 / 1 0 / 2 0 / 4 0 / 32	6	The direction properties refer to the direction of travel and the lights. The number of speed levels and the light bit depend on the locomotive controller.  Either the short main address or the long expanded address as a locomotive address.

PoM must be supported by the locomotive controller / central controller.

## CV Table for DCC

CV	Explanation	Values	Default	Notes
50 <sup>PoM</sup>	Alternative formats: Bit 0 : Analog AC off = 0 / Analog AC on = 1 Bit 1 : Analog DC off = 0 / Analog DC on = 1 Bit 2 : fx (MM) off = 0 / fx (MM) on = 1 Bit 3 : mfx off = 0 / mfx on = 1	0 - 15 0 / 1 0 / 2 0 / 4 0 / 8	15	Note: DCC cannot deactivate itself.
52 <sup>PoM</sup>	Motor type ... (Bit 0-4) ... Auxiliary – function outputs 5 and 6 ... Motor – Softdrive Sine ... Motor – without feedback control ... Motor – high-efficiency C90 ... Motor – bell armature ... Motor – direct current DC soft ... Motor – direct current DC hard ... Motor – direct current DC 1 Gauge also analog with feedback control ... (Bit 5) ... 0 : with analog with feedback control ... 1 : without analog feedback control	0 - 63 0 1 2 3 4 5 6 7 0 32	3	Selection of a motor type for additional settings for motor feedback control or Selection of additional function outputs on an H0 decoder. See extra table for how motor outputs work as additional auxiliary functions.
53 <sup>PoM</sup>	Motor feedback control – feedback control reference	0 - 255	150	Absolute Vmax for motor characteristic
54 <sup>PoM</sup>	Motor feedback control – feedback control parameter K	0 - 255	64	Feedback control portion P
55 <sup>PoM</sup>	Motor feedback control – feedback control parameter I	0 - 255	64	Feedback control portion I
56 <sup>PoM</sup>	Motor feedback control – feedback control influence	0 - 255	24	0 = PWM without feedback control for Sine (see also CV 52 motor type)
57 <sup>PoM</sup>	Steam locomotive sound interval of the steam chuffing at speed level 1	1 - 255 (0 - 63)* {x4}*	46	without a wheel sensor
58 <sup>PoM</sup>	Steam locomotive interval of the steam chuffing starting at speed level 2,	1 - 255 (0 - 63)* {x4}*	95	without a wheel sensor
63 <sup>PoM</sup>	Total volume	0 - 255	255	Total volume for all sounds. 0 = no sound

PoM must be supported by the locomotive controller / central controller.

## CV Table for DCC

CV	Explanation	Values	Default	Notes
64 <sup>PoM</sup>	Brake squealing threshold	0 - 255	60945=105 60946=55 60947=55	The higher the value the sooner the squealing begins, the lower the value the later the squealing begins. If the value is too low, no squealing is activated..
66 <sup>PoM</sup>	Forward trim	0 - 255	128	The CV value divided by 128 gives the factor with the speed level is multiplied when the locomotive is running forward.
67 <sup>PoM</sup> - 94 <sup>PoM</sup>	Speed table speed level 1 (Vmin) to speed table speed level 28 (Vmax)	0 - 255		
95 <sup>PoM</sup>	Reverse trim	0 - 255	128	The CV value divided by 128 gives the factor with the speed level is multiplied when the locomotive is running in reverse.
112 <sup>PoM</sup> 113 <sup>PoM</sup> 114 <sup>PoM</sup>	Physical output (mapping): front light mode Physical output (mapping): front light dimmer Physical output (mapping): front light period	0 - 16 0 - 255 0 - 255	1 255 20	See table*
bis 135 <sup>PoM</sup>	Physical output (mapping): rear light, Aux 1 to Aux 6 (each one in the 3rd block)			See table*
137 <sup>PoM</sup>	Switching range	0 - 128	128	128 = 50% of speed level, 64 = 25% of speed level

PoM must be supported by the locomotive controller / central controller.

\* An extensive table for function mapping can be found on the Internet at:  
[www.maerklin.de/de/produkte/tools\\_downloads/technische\\_infos.html](http://www.maerklin.de/de/produkte/tools_downloads/technische_infos.html)

## CV Table for DCC

CV	Explanation	Values	Default	Notes
138 <sup>PoM</sup>	Sound output: Brake squealing (volume)	0 - 255	180	0 = no sound
139 <sup>PoM</sup>	Sound output: Volume of running sounds	0 - 255	180	
140 <sup>PoM</sup>	Sound output: Volume for Sound 1	0 - 255	180	
- 155 <sup>PoM</sup>	up to Sound output: Volume for Sound 16	0 - 255	180	
173 <sup>PoM</sup>	Storing different states: Bit 0: Storing function states Bit 1: Storing speed Bit 2: After a reset starting up with/without ABV Bit 3 - 7: always 0	0 / 1 0 / 2 0 / 4	7	0 = do not store, value = store Individual values must be added.
174 <sup>PoM</sup>	Storing different states: Bit 0: Storing direction of travel Bit 1 - 7: always 0	0 / 1	1	0 = do not store 1 = store
176 <sup>PoM</sup>	Vmin Analog DC	0 - 255	100	Must be smaller than CV 177
177 <sup>PoM</sup>	Vmax Analog DC	0 - 255	255	Must be larger than CV 176
178 <sup>PoM</sup>	Vmin Analog AC	0 - 255	100	Must be smaller than CV 179
179 <sup>PoM</sup>	Vmax Analog AC	0 - 255		Must be larger than CV 178
257 <sup>PoM</sup>	Function assignment (mapping): Function FL forward A	0 - 255	1	See table*
258 <sup>PoM</sup>	Function assignment (mapping): Function FL forward A	0 - 255	0	
259 <sup>PoM</sup>	Function assignment (mapping): Function FL forward A	0 - 255	0	
260 <sup>PoM</sup>	Function assignment (mapping): Function FL forward A	0 - 255	0	
bis 445	Function assignment (mapping): drive backward	—		See table**

PoM must be supported by the locomotive controller / central controller.

\* An extensive table for function mapping can be found on the Internet at: [www.maerklin.de/de/produkte/tools\\_downloads/technische\\_infos.html](http://www.maerklin.de/de/produkte/tools_downloads/technische_infos.html)

## Troubleshooting.

When operating with different protocols you may have problems in each mode at the same time. – We recommend reducing the number of protocols. Deactivate protocols in the locomotive decoder that are not needed and also deactivate if possible protocols in the central controller that are not needed.

The locomotive jerks and falters – Check the CV setting for motor variations, change if necessary, or carry out a reset to the factory settings.

The locomotive does not run in analog. – The automatic analog recognition is deactivated and must be activated again (see CV table).

The locomotive (decoder) does not react. – Check the wiring and the solder joints, redo if necessary. Check the connector for the decoder to make sure it has permanent contact and check the way it was installed.

mfX/DCC operation: Locomotives standing on the layout start running suddenly during mfX registration. – Deactivate the automatic analog recognition on these locomotives.

The locomotive does not run. – The function “open doors / close doors” is still active. Turn off the function “close doors”; after the sound ends the locomotive will run according to the ABV that has been set.



## Disposing

Products marked with a trash container with a line through it may not be disposed of at the end of their useful life in the normal household trash. They must be taken to a collection point for the recycling of electrical and electronic devices. There is a symbol on the product, the operating instructions, or the packaging to this effect. The materials in these items can be used again according to this marking. By reusing old devices, materially recycling, or recycling in some other form of old devices such as these you make an important contribution to the protection of our environment. Please ask your city, town, community, or county authorities for the location of the appropriate disposal site.

## Warranty

The warranty card included with this product specifies the warranty conditions.

- Please contact your authorized Märklin dealer for repairs or contact:

### U.S. only:

Wm. K. Walther Inc.  
5601 W. Florist Ave.  
Milwaukee, WI 53218

### GB only

Gebr. Märklin & Cie. GmbH  
Reparaturservice  
Stuttgarter Str. 55 - 57  
73033 Göppingen  
Deutschland  
Tel: +49 7161 608 222  
E-Mail: Service@maerklin.de

## My personal decoder settings

### Locomotive:

<b>Adress</b>		<b>CV -</b>	
<b>CV -</b>		<b>CV -</b>	
<b>CV -</b>		<b>CV -</b>	
<b>CV -</b>		<b>CV -</b>	
<b>CV -</b>		<b>CV -</b>	
<b>CV -</b>		<b>CV -</b>	
<b>CV -</b>		<b>CV -</b>	
<b>CV -</b>		<b>CV -</b>	
<b>CV -</b>		<b>CV -</b>	
<b>CV -</b>		<b>CV -</b>	



## My personal decoder settings

### Locomotive:

<b>Adress</b>		<b>CV -</b>	
<b>CV -</b>		<b>CV -</b>	
<b>CV -</b>		<b>CV -</b>	
<b>CV -</b>		<b>CV -</b>	
<b>CV -</b>		<b>CV -</b>	
<b>CV -</b>		<b>CV -</b>	
<b>CV -</b>		<b>CV -</b>	
<b>CV -</b>		<b>CV -</b>	
<b>CV -</b>		<b>CV -</b>	
<b>CV -</b>		<b>CV -</b>	

This device complies with Part 15 of the FCC Rules.

Operation is subject to the following two conditions:

- (1) This device may not cause harmful interference, and
- (2) this device must accept any interference received, including interference that may cause undesired operation.

Your local authorized Märklin dealer:  
[www.RJFtrains.com](http://www.RJFtrains.com)  
e-mail: [RJFtrains@aol.com](mailto:RJFtrains@aol.com)  
Phone: 914-232-5546

Gebr. Märklin & Cie. GmbH  
Stuttgarter Str. 55 - 57  
73033 Göppingen  
Deutschland  
[www.maerklin.com](http://www.maerklin.com)



181233/1111/Ha2Ef  
Änderungen vorbehalten  
© Gebr. Märklin & Cie. GmbH